

SPARE PARTS ORGANIZER

**Storage & Order
Picking Solution**

Stack & Hanging Bins



Application: Aviation & Aerospace, Automobile, Home Appliance, Shipbuilding, Lean Manufacturing, Electronics & E-commerce, Self storage, etc.

Features & Functions:

- Raw material, Eco-friendly
- Sturdy, Durable & Heavy Loading
- Hanging & Stacking are both available
- Semi-open front for easily picking
- Can be used separately, together with shelf, cabinet ,etc

Regular Color: ● ● ●

Customization:  

Design Highlights

01 Horizontal Connection
Bins can be horizontal connected to improve structural stability



02 Vertical Connection
Bins can be vertical connected with stanchions to extend picking space for improving picking efficiency

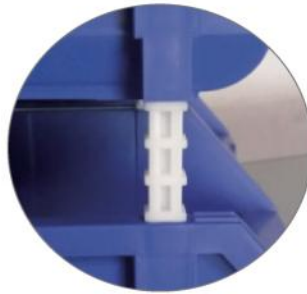

03 Hanging Function
Hanging slot design to make the bins can be also used with louvered panel

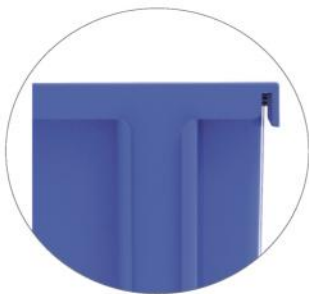

04 Dividers
Using vertical or horizontal dividers to divide the bins to multiple spaces to store different SKUs

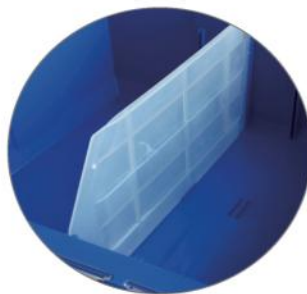

Application



Specification

Model	External Dimension L×W×Hmm	Internal Dimension L×W×Hmm	Loading (kg)	Stack Load(kg)	Stackable	Wall Mounted	Dividers Available
TK001	160×100×74	141×81×39	5	25	√	√	×
TK002	240×150×124	222×128×59	8	40	√	√	×
TK003	340×200×155	317×174×76	15	60	√	√	×
TK004	450×200×177	414×172×94	30	150	√	√	×
TK005	450×300×177	414×272×94	40	200	√	√	×
TK006	600×400×220	550×360×135	50	250	√	×	√
TK007	280×214×175	259×189×94	20	80	√	√	√
TK008	370×214×175	334×189×94	30	150	√	√	√
TK010	370×420×175	334×392×94	35	175	√	√	√
TK011	110×105×50	95×91×26	3	0	×	√	×
TK012	140×105×75	124×91×39	3	0	×	√	×
TK013	190×105×75	174×91×39	3	0	×	√	×
TK014	220×140×125	202×120×61	10	0	×	√	×
TK015	270×140×125	252×120×61	10	0	×	√	×
TK016	300×175×170	282×152×77	15	0	×	√	×

Model Details

TK001

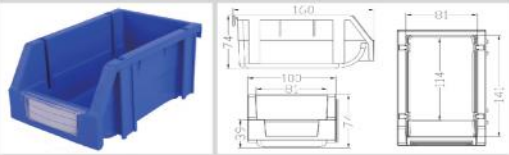

Carton Size: 340*330*235mm
 Qty/Ctn: 24
 Container Loading
 20GP: 1162 Ctns 40HQ: 2636 Ctns

External Dim:	100*160*74mm	Dropping Test:	3m gravity drop test(ISO2248-1985)
Internal Dim:	81*141*70mm	Impact Test:	≥168in/lbs (Gardner)
Loading:	5kg	Color:	Blue,red & yellow/customized available
Stack Loading:	30kg	Material:	Virgin Impact PP
Hanging Loading:	3kg	Temperature:	-20°C~70°C

TK002



Carton Size: 500*490*560mm
 Qty/Ctn: 36
 Container Loading
 20GP: 176 Ctns 40HQ: 436 Ctns

External Dim:	150*240*124mm	Dropping Test:	3m gravity drop test(ISO2248-1985)
Internal Dim:	128*222*120mm	Impact Test:	≥168in/lbs (Gardner)
Loading:	8kg	Color:	Blue,red & yellow/customized available
Stack Loading:	60kg	Material:	Virgin Impact PP
Hanging Loading:	6kg	Temperature:	-20°C~70°C

TK003



Carton Size: 665*355*690mm
 Qty/Ctn: 18
 Container Loading
 20GP: 177 Ctns 40HQ: 446 Ctns

External Dim:	200*340*155mm	Dropping Test:	3m gravity drop test(ISO2248-1985)
Internal Dim:	174*317*150mm	Impact Test:	≥168in/lbs (Gardner)
Loading:	15kg	Color:	Blue,red & yellow/customized available
Stack Loading:	150kg	Material:	Virgin Impact PP
Hanging Loading:	8kg	Temperature:	-20°C~70°C

TK004



Carton Size: 655*485*560mm
 Qty/Ctn: 12
 Container Loading
 20GP: 168 Ctns 40HQ: 396 Ctns

External Dim:	200*450*177mm	Dropping Test:	3m gravity drop test(ISO2248-1985)
Internal Dim:	172*414*170mm	Impact Test:	≥184in/lbs (Gardner)
Loading:	30kg	Color:	Blue,red & yellow/customized available
Stack Loading:	300kg	Material:	Virgin Impact PP
Hanging Loading:	15kg	Temperature:	-20°C~70°C

TK005

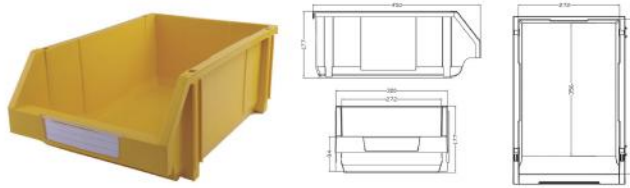

Carton Size: 570*480*530mm
 Qty/Ctn: 8
 Container Loading
 20GP: 192 Ctns 40HQ: 480 Ctns

External Dim:	300*450*177mm	Dropping Test:	3m gravity drop test(ISO2248-1985)
Internal Dim:	272*414*170mm	Impact Test:	≥184in/lbs (Gardner)
Loading:	50kg	Color:	Blue,red & yellow/customized available
Stack Loading:	500kg	Material:	Virgin Impact PP
Hanging Loading:	18kg	Temperature:	-20°C~70°C

TK007



Carton Size: 570*480*530mm
 Qty/Ctn: 16
 Container Loading
 20GP: 192 Ctns 40HQ: 480 Ctns

External Dim:	214*280*175mm	Dropping Test:	3m gravity drop test(ISO2248-1985)
Internal Dim:	189*259*170mm	Impact Test:	≥184in/lbs (Gardner)
Loading:	22kg	Color:	Blue,red & yellow/customized available
Stack Loading:	200kg	Material:	Virgin Impact PP
Hanging Loading:	12kg	Temperature:	-20°C~70°C

TK006



Carton Size: 660×420×565mm
 Qty: 4pcs/Carton
 Container Load Qty
 20GP: 181 CARTONS, 724pcs
 40hq: 425 CARTONS, 1700pcs

External Dim:	600*400*220mm	Dropping Test:	3m gravity dropping test(ISO2248-1985)
Internal Dim:	540*367*210mm	Impact Test:	≥168in/lbs (Gardner Impact Test)
Loading:	50kg	Stock Color:	Blue
Stack Loading:	500kg	Material:	Virgin Impact PP
		Work Temp:	-20°C~70°C

TK008

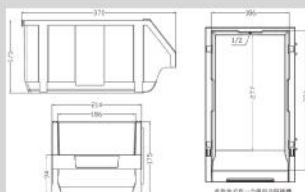

Carton Size: 490*395*555mm

Qty/Ctn: 8

Container Loading

20GP: 304 Ctns 40HQ: 726 Ctns

External Dim:	214*370*175mm	Dropping Test:	3m gravity drop test(ISO2248-1985)
Internal Dim:	186*334*94mm	Impact Test:	≥184in/lbs (Gardner)
Loading:	30kg	Color:	Blue,red & yellow/customized available
Stack Loading:	300kg	Material:	Virgin Impact PP
Hanging Loading:	13kg	Temperature:	-20°C~70°C

TK010

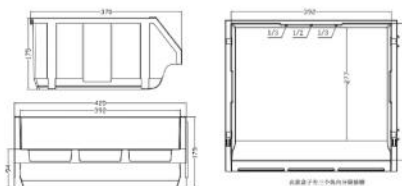

Carton Size: 900*395*550mm

Qty/Ctn: 8

Container Loading

20GP: 168 Ctns 40HQ: 390 Ctns

External Dim:	420*370*175mm	Dropping Test:	3m gravity drop test(ISO2248-1985)
Internal Dim:	392*334*94mm	Impact Test:	≥184in/lbs (Gardner)
Loading:	35kg	Color:	Blue,red & yellow/customized available
Stack Loading:	350kg	Material:	Virgin Impact PP
Hanging Loading:	20kg	Temperature:	-20°C~70°C

TK011

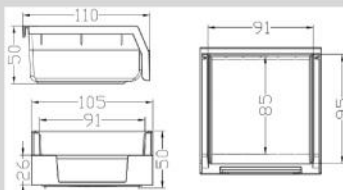

Carton Size: 255*250*190mm

Qty/Ctn: 24

Container Loading

20GP: 2727 Ctns 40HQ: 6483 Ctns

External Dim:	105*110*50mm	Dropping Test:	3m gravity drop test(ISO2248-1985)
Internal Dim:	91*95*46mm	Impact Test:	≥168in/lbs (Gardner)
Loading:	5kg	Color:	Blue,red & yellow/customized available
Hanging Loading:	3kg	Material:	Virgin Impact PP
Volume:	0.2L	Temperature:	-20°C~70°C

TK012

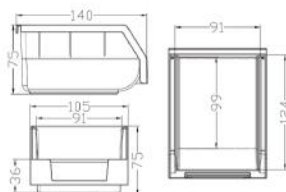

Carton Size: 305*220*280mm

Qty/Ctn: 24

Container Loading

20GP: 1768 Ctns 40HQ: 4140 Ctns

External Dim:	105*140*75mm	Dropping Test:	3m gravity drop test(ISO2248-1985)
Internal Dim:	91*124*70mm	Impact Test:	≥168in/lbs (Gardner)
Loading:	5kg	Color:	Blue,red & yellow/customized available
Hanging Loading:	3kg	Material:	Virgin Impact PP
Volume:	0.4L	Temperature:	-20°C~70°C

TK013

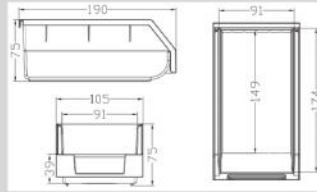

Carton Size: 415*225*260mm

Qty/Ctn: 24

Container Loading

20GP: 1245 Ctns 40HQ: 2908 Ctns

External Dim:	105*190*75mm	Dropping Test:	3m gravity drop test(ISO2248-1985)
Internal Dim:	91*174*70mm	Impact Test:	≥168in/lbs (Gardner)
Loading:	7kg	Color:	Blue,red & yellow/customized available
Hanging Loading:	3kg	Material:	Virgin Impact PP
Volume:	0.6L	Temperature:	-20°C~70°C

TK014

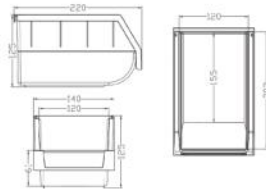

Carton Size: 450*305*250mm

Qty/Ctn: 12

Container Loading

20GP: 999 Ctns 40HQ: 2367 Ctns

External Dim:	140*220*125mm	Dropping Test:	3m gravity drop test(ISO2248-1985)
Internal Dim:	120*202*120mm	Impact Test:	≥168in/lbs (Gardner)
Loading:	15kg	Color:	Blue,red & yellow/customized available
Hanging Loading:	10kg	Material:	Virgin Impact PP
Volume:	1.5L	Temperature:	-20°C~70°C

TK015

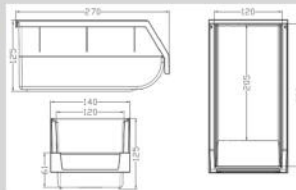

Carton Size: 445*305*290mm

Qty/Ctn: 12

Container Loading

20GP: 812 Ctns 40HQ: 1968 Ctns

External Dim:	140*270*125mm	Dropping Test:	3m gravity drop test(ISO2248-1985)
Internal Dim:	120*252*120mm	Impact Test:	≥168in/lbs (Gardner)
Loading:	18kg	Color:	Blue,red & yellow/customized available
Hanging Loading:	10kg	Material:	Virgin Impact PP
Volume:	1.8L	Temperature:	-20°C~70°C

TK016

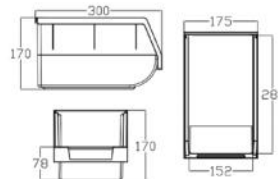
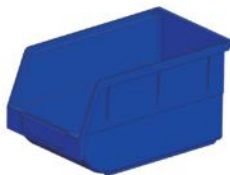

Carton Size: 620*490*540mm

Qty/Ctn: 30

Container Loading

20GP: 180 Ctns 40HQ: 436 Ctns

External Dim:	300*175*170mm	Dropping Test:	3m gravity drop test(ISO2248-1985)
Internal Dim:	281*152*165mm	Impact Test:	≥168in/lbs (Gardner)
Loading:	10kg	Color:	Blue,red & yellow/customized available
Hanging Loading:	6kg	Material:	Virgin Impact PP
Volume:	7.0L	Temperature:	-20°C~70°C

Bin Picking Rack

Picking bin rack using together with bins & metal hools, suitable for different material & tools organization. Assisting workshop and warehouse 5s management, maximize using of space, improving picking efficiency.

- Main Model: K-Picking Bin Rack
- Type of Picking Rack: R-Starter Rack
L-Added Rack
M-Moving
- Sides: 1-Single Side
2-Double Sides
- Height: 2-2 Panels High
3-3 Panels High
4-4 Panels High

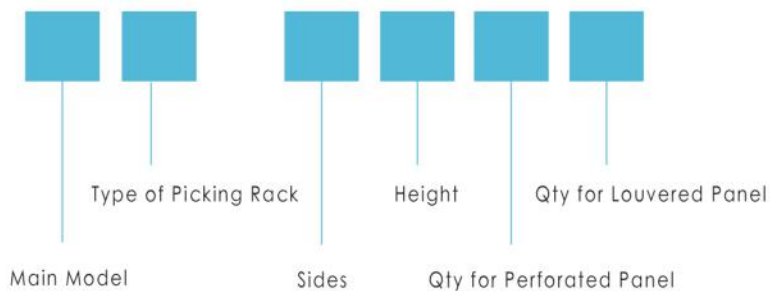

Design Highlights



Perforated Panel

Using together with metal hooks to organize tools



Louvered Panel

Using together with bins to organize parts



Handles



Panel assembling

Bins Configuration



Bins Qty while Full Equipped

Optional bin models



Hanging Bins

TK011,TK012,TK013
TK014, TK015



Stack & Hanging Bins

TK001,TK002,TK003
TK004, TK005,TK007
TK008,TK010

Specification

Model	Specification (mm)		Panel Qty	Bins Qty While Full Equipped								
	L	W		H	TK011	TK012	TK013	TK014	TK015	TK007	TK008	TK010
KM-2240	960	610	1110	4	144	144	144	72	72	32	32	16
KM-2360	960	610	1560	6	208	208	208	108	108	48	48	24
KR-1330	970	375	1450	3	104	104	104	54	54	16	16	8
KR-1440	970	375	1910	4	144	144	144	72	72	32	32	16
KR-2360	970	630	1450	6	208	208	208	108	108	48	48	24
KR-2480	970	630	1910	8	288	288	288	144	144	64	64	32
KL-1330	930	375	1450	3	104	104	104	54	54	16	16	8
KL-2360	930	630	1450	6	208	208	208	108	108	48	48	24
KL-1440	930	375	1910	4	144	144	144	72	72	32	32	16
KL-2480	930	630	1910	8	288	288	288	144	144	64	64	32

Shelf Storage Bins



Shelf Storage Bin is edge tools for spare parts organizing and picking. It is widely used in workshop, hardware shop, E-commerce storage and picking line, etc. Many bright colors help you improving visual management.

Regular Color: ● ● ●

Customization:  

Design Highlights

01 Horizontal Divider

7 horizontal divider slots divide the bins to 1/2,1/3,1/4,1/6



02 Vertical Divider

3 vertical divider slots divide the bins to 1/2,1/3



03 Big Label Area

Big label area, barcode or label paper for manual or system control of the bins



04 Nestable

Nestable design, save 40%~65% transportation space.



With Wire Shelving



With Steel Shelving

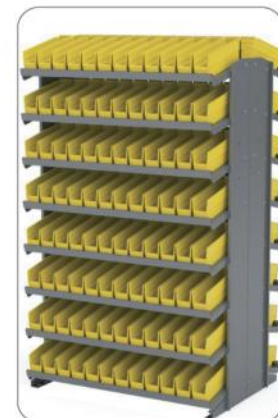

With Picking Rack

Specification

Model	External Dimension D×W×H (mm)	Internal Dimension D×W×H (mm)	Carton Dimension D×W×H (mm)	Qty/Ctn	Material	Loading
TK3115	300×100×150	280×79×88	610×405×405	40	Virgin Impact PP	≤12kg
TK3215	300×200×150	280×178×88	610×605×405	30	Virgin Impact PP	≤15kg
TK3315	300×300×150	280×277×88	610×605×405	20	Virgin Impact PP	≤20kg
TK3415	300×400×150	280×376×88	610×405×405	10	Virgin Impact PP	≤25kg
TK5215	500×200×150	480×178×88	510×605×405	15	Virgin Impact PP	≤25kg
TK5315	500×300×150	480×277×88	510×605×405	10	Virgin Impact PP	≤25kg
TK5415	500×400×150	480×376×88	510×405×405	5	Virgin Impact PP	≤30kg
TK6215	600×200×150	580×178×88	610×605×405	15	Virgin Impact PP	≤25kg
TK6315	600×300×150	580×277×88	610×605×405	10	Virgin Impact PP	≤30kg
TK6415	600×400×150	580×376×88	610×405×405	5	Virgin Impact PP	≤35kg

Model Details



TK3115

- External Size: 300×100×150mm • Internal Size: 280×79×88mm
- Volume: 1.9L • Material: High Impact PP
- Load Capacity: ≤12kg • 20GP Load Qty: 11120
- Carton Size: 610×405×405 • 40HQ Load Qty: 27040

TK3215

- External Size: 300×200×150mm • Internal Size: 280×178×88mm
- Volume: 4.4L • Material: High Impact PP
- Load Capacity: ≤15kg • 20GP Load Qty: 5580
- Carton Size: 610×605×405 • 40HQ Load Qty: 13710



TK3315

- External Size: 300×300×150mm • Internal Size: 280×277×88mm
- Volume: 6.8L • Material: High Impact PP
- Load Capacity: ≤20kg • 20GP Load Qty: 3720
- Carton Size: 610×605×405 • 40HQ Load Qty: 9140

TK3415

- External Size: 300×400×150mm • Internal Size: 280×376×88mm
- Volume: 9.3L • Material: High Impact PP
- Load Capacity: ≤25kg • 20GP Load Qty: 2780
- Carton Size: 610×405×405 • 40HQ Load Qty: 6760



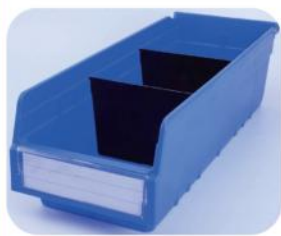

TK5215

- External Size: 500×200×150mm • Internal Size: 480×178×88mm
- Volume: 7.5L • Material: High Impact PP
- Load Capacity: ≤25kg • 20GP Load Qty: 3540
- Carton Size: 510×605×405 • 40HQ Load Qty: 8745

TK5315

- External Size: 500×300×150mm • Internal Size: 480×277×88mm
- Volume: 11.7L • Material: High Impact PP
- Load Capacity: ≤25kg • 20GP Load Qty: 2360
- Carton Size: 510×605×405 • 40HQ Load Qty: 5830

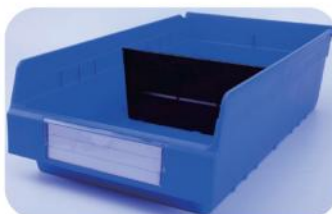

TK5415

- External Size: 500×400×150mm • Internal Size: 480×377×88mm
- Volume: 15.9L • Material: High Impact PP
- Load Capacity: ≤30kg • 20GP Load Qty: 1660
- Carton Size: 510×405×405 • 40HQ Load Qty: 4120

TK6215

- External Size: 600×200×150mm • Internal Size: 580×178×88mm
- Volume: 9.1L • Material: High Impact PP
- Load Capacity: ≤25kg • 20GP Load Qty: 2760
- Carton Size: 610×605×405 • 40HQ Load Qty: 6870

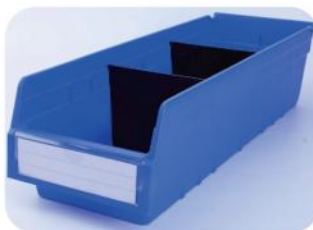

TK6315

- External Size: 600×300×150mm • Internal Size: 580×277×88mm
- Volume: 14.1L • Material: High Impact PP
- Load Capacity: ≤30kg • 20GP Load Qty: 1840
- Carton Size: 610×605×405 • 40HQ Load Qty: 4580

TK6415

- External Size: 600×400×150mm • Internal Size: 580×377×88mm
- Volume: 19.2L • Material: High Impact PP
- Load Capacity: ≤35kg • 20GP Load Qty: 2390
- Carton Size: 610×405×405 • 40HQ Load Qty: 3380



European Shelf Trays



European shelf tray size is an European standard size boxes for spare parts organizing. It is used together with metal shelf to make it to be a drawer bin. Also it can be used in carrousel to organize spare parts. It is widely used in electrical industry, military industry, research institutes, etc.

Regular Color: ●

Customization:



Design Highlights

- 01 **Clear Dust-free Label Cover**
Big label area for more information, beautiful & more practical.



- 03 **Label without using cover**
Special slot design to make sure label is useful without label cover



- 02 **Horizontal Dividers**
Max 11 dividers to improve storage space flexibility



- 04 **Extended Function**
Can be used as a drawer bin when equipped with chromed wire bar and spring



Application



Specification

Model	Volume	External Dimension D×W×H (mm)	Internal Dimension D×W×H (mm)	Carton Dimension D×W×H (mm)	Qty/Ctn	Material	Loading
TK3109	2.0L	300×117×90	262×93×82	610×480×520	48	Virgin Impact PP	≤5kg
TK4109	2.7L	400×117×90	362×93×82	410×480×520	24	Virgin Impact PP	≤10kg
TK5109	3.5L	500×117×90	462×93×82	510×480×520	24	Virgin Impact PP	≤11kg
TK6109	4.3L	600×117×90	562×93×82	610×480×520	24	Virgin Impact PP	≤12kg
TK3209	4.5L	300×234×90	262×210×82	610×480×520	24	Virgin Impact PP	≤10kg
TK4209	6.2L	400×234×90	362×210×82	410×480×520	12	Virgin Impact PP	≤14kg
TK5209	7.9L	500×234×90	462×210×82	510×480×520	12	Virgin Impact PP	≤16kg
TK6209	9.7L	600×234×90	562×210×82	610×480×520	12	Virgin Impact PP	≤18kg
TK3214	7.2L	300×234×140	262×210×132	610×480×550	16	Virgin Impact PP	≤13kg
TK4214	10L	400×234×140	362×210×132	410×480×550	8	Virgin Impact PP	≤16kg
TK5214	12.8L	500×234×140	462×210×132	510×480×550	8	Virgin Impact PP	≤21kg
TK6214	15.6L	600×234×140	562×210×132	610×480×550	8	Virgin Impact PP	≤26kg

Model Details



TK3109

- External Size: 300×117×90mm
- Internal Size: 262×93×82mm
- Volume: 2.0L
- Material: High Impact PP
- Load Capacity: ≤5kg
- 20GP Load Qty: 8832
- Carton Size: 610×480×520
- 40HQ Load Qty: 21888

TK3209

- External Size: 300×234×90mm
- Internal Size: 262×210×82mm
- Volume: 4.5L
- Material: High Impact PP
- Load Capacity: ≤10kg
- 20GP Load Qty: 4416
- Carton Size: 610×480×520
- 40HQ Load Qty: 10944



TK3214

- External Size: 300×234×140mm
- Internal Size: 262×210×132mm
- Volume: 7.2L
- Material: High Impact PP
- Load Capacity: ≤13kg
- 20GP Load Qty: 2928
- Carton Size: 610×480×550
- 40HQ Load Qty: 7168

TK4109

- External Size: 400×117×90mm
- Internal Size: 362×93×82mm
- Volume: 2.7L
- Material: High Impact PP
- Load Capacity: ≤10kg
- 20GP Load Qty: 7008
- Carton Size: 410×480×520
- 40HQ Load Qty: 17184





TK4214

- External Size: 400×234×140mm • Internal Size: 362×210×132mm
- Volume: 10.0L • Material: High Impact PP
- Load Capacity: ≤16kg • 20GP Load Qty: 2216
- Carton Size: 410×480×550 • 40HQ Load Qty: 5448

TK4209

- External Size: 400×234×90mm • Internal Size: 362×210×82mm
- Volume: 6.2L • Material: High Impact PP
- Load Capacity: ≤14kg • 20GP Load Qty: 3504
- Carton Size: 410×480×520 • 40HQ Load Qty: 8592



TK5209

- External Size: 500×234×90mm • Internal Size: 462×210×82mm
- Volume: 7.9L • Material: High Impact PP
- Load Capacity: ≤16kg • 20GP Load Qty: 2304
- Carton Size: 510×480×520 • 40HQ Load Qty: 5760

TK5109

- External Size: 500×117×90mm • Internal Size: 462×93×82mm
- Volume: 3.5L • Material: High Impact PP
- Load Capacity: ≤11kg • 20GP Load Qty: 4608
- Carton Size: 510×480×520 • 40HQ Load Qty: 11520



TK6109

- External Size: 600×117×90mm • Internal Size: 562×93×82mm
- Volume: 4.3L • Material: High Impact PP
- Load Capacity: ≤12kg • 20GP Load Qty: 4416
- Carton Size: 610×480×520 • 40HQ Load Qty: 10944

TK5214

- External Size: 500×234×140mm • Internal Size: 462×210×132mm
- Volume: 12.8L • Material: High Impact PP
- Load Capacity: ≤21kg • 20GP Load Qty: 1536
- Carton Size: 510×480×550 • 40HQ Load Qty: 3840



TK6214

- External Size: 600×234×140mm • Internal Size: 562×210×132mm
- Volume: 15.6L • Material: High Impact PP
- Load Capacity: ≤26kg • 20GP Load Qty: 1464
- Carton Size: 610×480×550 • 40HQ Load Qty: 3584

TK6209

- External Size: 600×234×90mm • Internal Size: 562×210×82mm
- Volume: 9.7L • Material: High Impact PP
- Load Capacity: ≤18kg • 20GP Load Qty: 2208
- Carton Size: 610×480×520 • 40HQ Load Qty: 5472



Bin Cabinet

Bin Cabinet is a good storage and picking solution for spare parts. Except the standard size of bin cabinet, we also offer a wide range of customized sizes.

Both Stack storage bins, shelf storage bins and European standard trays can be used inside cabinet to organize spare parts.

Customized design and size service is available



Specification

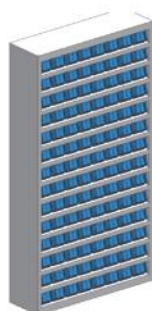

Model	Cabinet Size W × D × H	Levels	Bins Configuration
BC-3109	1000×305×1900	14	TK3109 × 112
BC-4109	1000×405×1900	14	TK4109 × 112
BC-5109	1000×505×1900	14	TK5109 × 112
BC-6109	1000×605×1900	14	TK6109 × 112

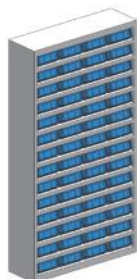

Model	Cabinet Size W × D × H	Levels	Bins Configuration
BC-3209	1000×305×1900	14	TK3209 × 56
BC-4209	1000×405×1900	14	TK4209 × 56
BC-5209	1000×505×1900	14	TK5209 × 56
BC-6209	1000×605×1900	14	TK6209 × 56



Model	Cabinet Size W × D × H	Levels	Bins Configuration
BC-3214	1000×305×1880	10	TK3214 × 40
BC-4214	1000×405×1880	10	TK4214 × 40
BC-5214	1000×505×1880	10	TK5214 × 40
BC-6214	1000×605×1880	10	TK6214 × 40



Model	Cabinet Size W × D × H	Levels	Bins Configuration
BC-300M	1000×305×1840	12	TK3109 × 32 TK3209 × 16 TK3214 × 16
BC-400M	1000×405×1840	12	TK4109 × 32 TK4209 × 16 TK4214 × 16
BC-500M	1000×505×1840	12	TK5109 × 32 TK5209 × 16 TK5214 × 16
BC-600M	1000×605×1840	12	TK6109 × 32 TK6209 × 16 TK6214 × 16

Drawer-Type Organizer Bin

Drawer-type organizer bins are widely used as parts organizer for various application:

Suitable scenarios: warehouses, shops, offices, hospitals, homes

Suitable parts: bolts & nuts, stationery, toys, headwear, jewelry, financial documents, mobile phone accessories, medical consumables, etc



Specification

Model	External Size mm	Internal Size mm	Max Dividers Option
DB-0	L111*W98*H48	L99*W82*H40	1
DB-1	L140*W92*H44	L118*W76*H35	2
DB-2	L180*W93*H50	L156*W81*H39	3
DB-3	L183*W110*H61	L155*W96*H50	3
DB-4	L222*W108*H55	L195*W97*H47	5
DB-5	L206*W135*H79	L175*W122*H69	4
DB-K5	L203*W141*H79	L176*W124*H69	4
DB-6	L242*W130*H76	L215*W115*H65	5
DB-6N	L235*W128*H75	L225*W123*H70	5
DB-7	L318*W159*H87	L291*W145*H71	7
DB-8	L287*W182*H110	L257*W167*H100	3
DB-K8	L288*W190*H111	L258*W169*H100	3
DB2-8	L287*W182*H110	L257*W167*H48	6
DB-A4M01	L351*W245*H95	L320*W230*H80	N/M
DB-A4M02	L351*W245*H95	L320*W230*H38 (2 drawers)	N/M
DB-A4XL	L378*W261*H112	L345*W243*H96	N/M

Features & Functions



There are buckles on both sides. align the buckles and press down vertically



Align the upper layer with the card point and press down firmly



Repeat the previous steps and so on for any combination



The box features textured grooves on all four sides. align with the corresponding grooves and push downwards vertically to lock it in place



Align the card slot and press down firmly



Repeat the previous steps and so on for any combination



Removable Dividers



Two Dividers for Free each Bin



Model Detail



2-Tier Drawer Bins

Model: DB2-8

Color Available: 



External Size: 287*182*110mm
Internal Size: 257*167*48mm(2 Bins)

Single Drawer A4 Files Bins

Model: DB-A4M01



Frame Size: 351*245*96mm
Drawer Size: 320*230*80mm

2-Tier Drawer A4 Files Bins

Model: DB-A4M02



Frame Size: 351*245*96mm
Drawer Size: 320*230*38mm (2 Drawers)

XL Single Drawer Files Bins

Model: DB-A4XL



Frame Size: 378*261*112mm
Drawer Size: 345*243*96mm



 Clear + Yellow



 Clear + White

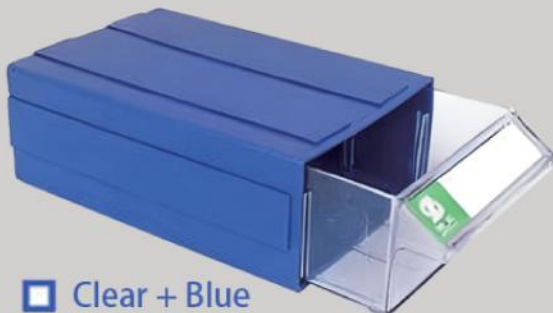

 Clear + Blue



 All Blue

Applications

Combining Bins to be a Shelf



Smartphone Screen Protector Organizer

Warehouse



Headware Organizer



Lego Bricks Organizer



Cream Glue Organizer



Bolts & Nuts Storage

